

SOLAR
EAR

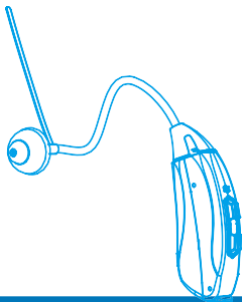

User Manual

Rocker! Your partner of graceful life

Rocker
206D

Contents

| | |
|--|--------|
| Preface..... | 2 |
| Features..... | 3 |
| Preparation..... | 4 |
| Operation..... | 6 |
| ON and OFF..... | 6 |
| How to wear your hearing instrument... 6 | Rocker |
| switch..... | 8 |
| Replacing the battery..... | 10 |
| Maintenance..... | 11 |
| Cleaning & changing tube..... | 11 |
| Cleaning the instrument..... | 12 |
| Low battery warning..... | 13 |
| Battery caring..... | 13 |
| Troubleshooting Guide..... | 14 |
| Appendix..... | 16 |
| Technical information..... | 16 |
| Working Condition..... | 17 |
| FDA information..... | 19 |

Preface

Congratulations! Welcome to a New Life created by 'Rocker' hearing aid device.

Please read this manual carefully before use.

Intended use

This hearing instrument is a kind of electronic device which amplifies sound from your surroundings. It is used to help hearing impaired people improve hearing ability by compensating for the hearing loss.

Scope

This user manual only applies to Rocker 206D hearing aid device.

Precautions

For patients with middle ear infection, it's suggested not to wear hearing instrument until cured or follow the doctor's advice. Please consult your hearing healthcare professional first if you have any questions about your hearing or your hearing instrument.

THE MANUFACTURER RESERVES THE RIGHT TO MODIFY THE TECHNICAL SPECIFICATIONS OF THE PRODUCT WITHOUT ANY PRIOR NOTICE.

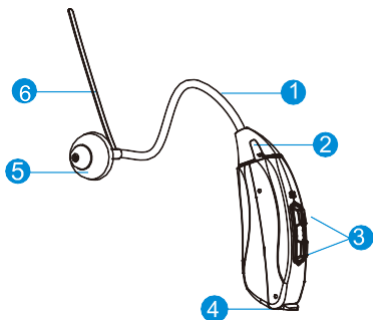

1. Sound tube
2. Microphone
3. Rocker switch
4. Battery door
5. Dome
6. Retention lock

THIN TUBE ACCESSORIES PACK

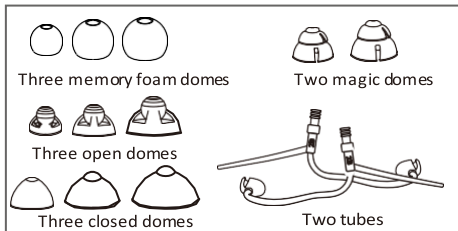

NOTICE: Please use closed dome to avoid whistling when you maximum the gain.

Packaging included:

| | |
|---------------------|----------------------------|
| 1x 6mm open dome | 1x 9mm memory foam dome 1x |
| 1x 9mm open dome | 11mm memory foam dome 1x |
| 1x 12mm open dome | 13mm memory foam dome 2x |
| 1x 10mm tulip dome | 2BL tube or 2BR tube |
| 1x 12mm tulip dome | 1x Brush |
| 1x 9mm closed dome | 1x Cleaning wire |
| 1x 12mm closed dome | |
| 1x 15mm closed dome | |

Battery

The ROCKER 206D uses a 312A battery. Please use the correct size of battery.

To upload a battery, position the battery with the positive (+) side up and insert it into the battery compartment section of the battery door.

If the battery is inserted incorrectly or upside down, the door will not close. Do not force the door closed.



CAUTION: Batteries are dangerous if swallowed! Keep batteries out of the reach of children. Seek immediate medical help when it happens.

Dome

Attach the dome

Push the dome over the grooves on the tube to mount it.

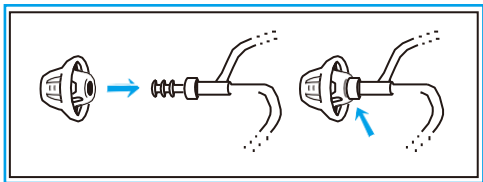

Attach the sound tube

To connect the sound tube with hearing aid, just plug into the adaptor.

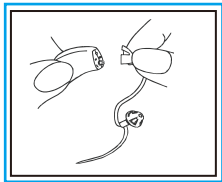

Note: Your hearing aid is supplied with two tubes.

RED lettering is for right ear.

BLUE lettering is for left ear.

ON and OFF

TO TURN ON - Gently open the battery door, insert battery and close the door.

The device is equipped with power-on delay function, so it needs a few seconds to get started.

TO TURN OFF - Simply open the battery door completely. Please store the instrument in safe and dry place.

Put on your hearing instrument

Before putting on your hearing instrument, please clean your ear and make sure the battery door is closed properly. Follow the procedure for inserting your instrument:

Step 1: Hold the sound tube;

Step 2: Place the instrument over the top of the ear;

Step 3: Gently insert the dome into ear canal;

Step 4: Move the retention lock and place it into the bowl of your ear.

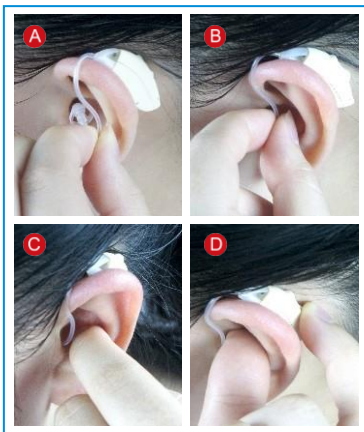

Note: If swelling or redness occurs, discontinue using and visit your hearing professional.

Rocker Switch

The rocker switch serves as a volume control as well as a memory switch.

Volume Control

Press the upper part of the switch to increase the volume.

Press the lower part to decrease the volume.

Memory Switch

Press and hold either part of the switch for 3 seconds to change the current program.



Short Press to increase volume level
Long press to switch program

Short Press to decrease volume level
Long press to switch program

Rocker 206D is pre-seted with 3 programs. When the hearing instrument is turned on, it will automatically be in program 1. Press the upper/lower half of the switch for 3 seconds, and the current listening program will change to another. The number of beeps corresponds to the program. The programs will cycle up in sequence 1,2,3,1,2 etc
Adjust the volume and the program that is most comfortable for you and meets the need of the environment that you are in.

Program 1: For normal and universal use.

Program 2: For noisy environment use.

Program 3: Good for watching TV.

Replacing the battery

1. Switch off the hearing instrument by opening the battery door.
2. Remove the old battery.
3. Remove the protective foil from the new battery.
4. Insert the new battery, be sure that the plus (+) is facing up.
5. Close the battery door.



Important: Handle the battery door gently. The operation requires only a minimum force. If there is any resistance when closing the battery door, ensure that the battery is correctly inserted. The battery door cannot be closed if the battery is inserted incorrectly.

Cleaning & Changing Tube

Cleaning

Use a soft cloth to wipe the instrument after use to remove any particles or moisture. The Cleaning Tool is used to remove debris / wax from the sound tubing and domes.

Changing

1. To remove tube gently rotate the sound tube holding the instrument firmly.
2. Pull sound tube from the hearing instrument.
3. To clean, insert the cleaning tool through the nose cone end. Thread all the way through the tube & domes.
4. To reassemble or change sound tubing simply line up and push tube until it snaps into place.

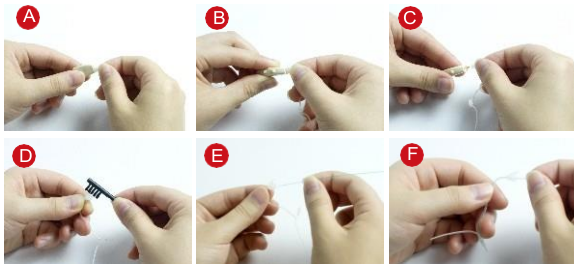

Cleaning the instrument

Ear wax is one of the main causes of hearing aids problems. Filter and other devices are used for preventing wax from entering the instrument.

It's suggested cleaning ear wax in the morning before you insert the instrument to your ear.

Clean your instrument with a soft, dry cloth and a small brush. Do the cleaning on a soft table to avoid damage or scratch in case the instrument falls.



Do not use water
or other fluids.

Low battery warning

When you hear two short beeps, it means that the battery is running out. Intermittent warning exists until you replace the battery.

The sound quality may be influenced after the first warning, this is normal and can be remedied by inserting a fresh battery in the hearing instrument.

Always remove the battery if your instrument is not in use for long periods of time.

Battery caring

The performance of hearing instrument greatly depends on the quality of the battery using.

- 1) It is important to use high-quality batteries. With reliable high-quality batteries, you can avoid periodic hearing instrument failures.
- 2) It is also important that the batteries are well packed before use. Each battery is therefore provided with an adhesive label which ensures the battery is sealed and fresh till use.
- 3) Never leave an exhausted battery in the hearing instrument. Exhausted battery may leak and it would damage the instrument.

Trouble shooting guide

| SYMPTOM | POSSIBLE CAUSES | SOLUTIONS |
|------------------------------|---|--|
| No sound | No battery | Insert the battery |
| | Dead or low battery | Replace battery |
| | Battery improperly inserted | Insert battery correctly |
| | Wax or debris in the microphone or receiver | Clean the instrument, remove and clean the dome |
| Not loud enough | Low battery | Replace battery |
| | Excessive ear wax | Consult your physician |
| | Volume set too low | Adjust the rocker volume control |
| | Wax or debris in the microphone or receiver | Clean both microphone and receiver with brush. Remove and clean the dome |
| | Hearing loss change | Contact your hearing care professional |
| Whistling, feedback | Loose insertion of hearing instrument | Remove and reinsert |
| | Excessive ear wax | Consult your physician |
| | Dome of improper size | Change domes of proper size |
| Not clear or distorted sound | Low battery | Replace battery |
| | Hearing instrument damaged | Contact your hearing care professional |
| | Hearing instrument settings not optimal | Contact your hearing care professional |

Help with whistling

Whistling is common for small amplifiers and is known as 'feedback'. It is caused by amplified sound from the hearing aid getting back to the microphone and being re-amplified. Choose a suitable earpiece is very important for better fitting.

The following tips will help reduce the occurrence of feedback whistle:

1. Reduce the volume.
 - >Turn off or lower the volume before inserting the instrument in your ear.
2. Securely position the instrument into your ear.
 - > Once the hearing aid is properly seated in your ear, the whistling will generally stop.
3. Clear the wax or debris in ear canal.
 - >Check your ear with help.
4. Change the ear piece or tubing.
 - >Change a new one or a different size one.
 - >Make sure the tubing is not broken or torn.

Appendix

Technical data

| Technical Data Peak | Rocker 206D |
|-------------------------|-------------|
| OSPL 90(dB SPL) HFA | 117 |
| OSPL 90(dB SPL) | 106 |
| Reference test Gain(dB) | 40 |
| HFAfull on Gain(dB) | 32 |
| THD @ 500Hz(%) | 3.0 |
| THD @ 800Hz(%) | 3.0 |
| THD @ 1600Hz(%) | 3.0 |
| EQ Input Noise(dB) | 30 |
| Battery Current(mA) | 1.3 |
| Frequency Range (Hz) | 300-5000 |

IEC 60118-7/2005
ANSI 3 . 22 - 2003

Working condition

Temperature: -20°C to 60°C / -4°F to 140°F

Relative humidity: ≤85%

Air pressure: 500 ~ 1100 kPa



Manufacturer

SOLAR
EAR



WWW.solarear.org

solarear@solarear.com.br

CE 0482



Special statement:

- ▶ A hearing aid will not restore normal hearing and will not prevent or improve a hearing impairment resulting from organic conditions.
- ▶ In most cases infrequent use of a hearing aid does not permit a user to attain full benefit from it.
- ▶ The use of a hearing aid is only part of hearing habilitation and may need to be supplemented by auditory training and instruction in lipreading.
- ▶ If your hearing instrument needs to be repaired, please contact your seller where you buy from firstly. The seller would provide you better solution. If you failed to contact with your seller, please contact at sales@usnewsound.com, the service center would give you proper solution.

FDA information

Warning to Hearing Aid Dispensers

A hearing aid dispenser should advise a prospective hearing aid user to consult promptly with a licensed physician (preferably an ear specialist) before dispensing a hearing aid if the hearing aid dispenser determines through inquiry, actual observation, or review of any other available information concerning the prospective user, that the prospective user has any of the following conditions:

- (i) Visible congenital or traumatic deformity of the ear.
- (ii) History of active drainage from the ear within the previous 90 days.
- (iii) History of sudden or rapidly progressive hearing loss within the previous 90 days.
- (iv) Acute or chronic dizziness.
- (v) Unilateral hearing loss of sudden or recent onset within the previous 90 days.
- (vi) Audiometric air-bone gap equal to or greater than 15 decibels at 500 hertz (Hz), 1,000 Hz, and 2,000 Hz.
- (vii) Visible evidence of significant cerumen accumulation or a foreign body in the ear canal.
- (viii) Pain or discomfort in the ear.

Important Notice for Prospective Hearing Aid Users

Good health practice requires that a person with a hearing loss have a medical evaluation by a licensed physician (preferably a physician who specializes in diseases of the ear) before purchasing a hearing aid. Licensed physicians who specialize in diseases of the ear are often referred to as otolaryngologists, otologists or otorhinolaryngologists.

The purpose of medical evaluation is to assure that all medically treatable conditions that may affect hearing are identified and treated before the hearing aid is purchased. Following the medical evaluation, the physician will give you a written statement that states that your hearing loss has been medically evaluated and that you may be considered a candidate for a hearing aid. The physician will refer you to an audiologist or a hearing aid dispenser, as appropriate, for a hearing aid evaluation.

The audiologist or hearing aid dispenser will conduct a hearing aid evaluation to assess your ability to hear with and without a hearing aid. The hearing aid evaluation will enable the audiologist or dispenser to select and fit a hearing aid to your individual needs.

If you have reservations about your ability to adapt to amplification, you should inquire about the availability of a trial-rental or purchase-option program. Many hearing aid dispensers now offer programs that permit you to wear a hearing aid for a period of time for a nominal fee after which you may decide if you want to purchase the hearing aid.

Federal law restricts the sale of hearing aids to those individuals who have obtained a medical evaluation from a licensed physician. Federal law permits a fully informed adult to sign a waiver statement declining the medical evaluation for religious or personal beliefs that preclude consultation with a physician.

The exercise of such a waiver is not in your best health interest and its use is strongly discouraged.

Children with hearing loss

In addition to seeing a physician for a medical evaluation, a child with a hearing loss should be directed to an audiologist for evaluation and rehabilitation since hearing loss may cause problems in language development and the educational and social growth of a child. An audiologist is qualified by training and experience to assist in the evaluation and rehabilitation of a child with a hearing loss.

CE₀₄₈₂ FDA MED/CERT

E- mail: solarear@solarear.com.br

www.solarear.org

Version: A/0